

EWT7078K6WA
EWT8078K6WA
EWT9078K6WA
EWT0H78K6WA

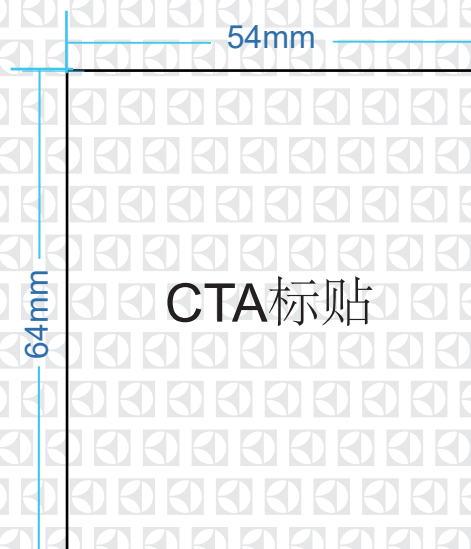

IMPORTANT INFORMATION THAT MAY IMPACT YOUR MANUFACTURER'S WARRANTY

Adherence to the directions for use in this manual is extremely important for health and safety. Failure to strictly adhere to the requirements in this manual may result in personal injury, property damage and affect your ability to make a claim under the Electrolux manufacturer's warranty provided with your product. Products must be used, installed and operated in accordance with this manual. You may not be able to claim on the Electrolux manufacturer's warranty in the event that your product fault is due to failure to adhere to this manual.

WE'RE THINKING OF YOU

Thank you for purchasing an Electrolux appliance. You've chosen a product that brings with it decades of professional experience and innovation. Ingenious and stylish, it has been designed with you in mind. So whenever you use it, you can be safe in the knowledge that you'll get great results every time. Welcome to Electrolux.



Visit our website to:



Get usage advice, brochures, trouble shooter, service information, buy accessories & spare parts, online product registration : **www.electrolux.com**

CUSTOMER CARE AND SERVICE

We recommend the use of original spare parts. When contacting Service, ensure that you have the following data available. The information can be found on the rating plate. Model, PNC, Serial Number.

-  Warning / Caution-Safety information.
-  General information and tips.
-  Environmental information.

Subject to change without notice.

CONTENTS

1.  SAFETY INFORMATION 4	6. CARE AND CLEANING..... 20
1.1 Conditions Of Use..... 4	6.1 Cleaning The Dispenser20
1.2 Child Safety..... 4	6.2 Cleaning The Drawer Recess...20
1.3 General Safety..... 5	6.3 Clean The Inner Tub Filter.....20
1.4 Installation..... 5	6.4 Cleaning The Water Inlet Filter.20
1.5 Use..... 6	6.5 Cleaning Your Washing Machine.....21
2. PRODUCT DESCRIPTION..... 7	6.6 Cleaning Stains In The Washbowl.....21
2.1 Parts 7	7. TROUBLESHOOTING 22
2.2 Product Features..... 8	7.1 Possible Failures 22
3. CONTROL PANEL..... 9	7.2 Yellowing Or Greying Clothes.23
3.1 Control Panel Description.....9	8. TECHNICAL DATA..... 24
3.2 Program Chart.....10	9. INSTALLATION 25
3.3 Program Options Compatibility.11	9.1 Unpacking 25
3.4 Options.....12	9.2 Positioning 27
3.5 Settings.....13	9.3 Water Inlet 27
4. DAILY USE..... 14	9.4 Installation of drain hose..... 28
4.1 Starting Your Washing Machine.14	10. ENVIRONMENT CONCERNS.29
4.2 Load The Washing Machine.....14	10.1 Packaging Materials 29
4.3 Add Fabric Softener.....14	10.2 Old Machine 29
4.4 Setting a Program.....15	10.3 Ecological Hints..... 29
4.5 Starting a Program.....16	
4.6 Interruption Of A Program16	
4.7 Changing A Program.....16	
4.8 Changing The Options.....16	
4.9 At The End Of The Program.....16	
5. WASHING HINTS..... 17	
5.1 Sort Your Washing Into Separate Wash Loads..... 17	
5.2 Detergent 18	
5.3 A Guide To Stain Removal.....19	

1. SAFETY INFORMATION

1.1 Conditions Of Use

This appliance is intended to be used in household and similar applications such as:

- staff kitchen areas in shops, offices and other working environment;
- farm houses;
- by clients in hotels, motels, and other residential type environments;
- bed and breakfast type environments;
- areas for communal use in blocks of flats or in laundrettes.



WARNING! The appliance must not be supplied

through an external switching device, such as timer, or connected to a circuit that is regularly switched on and off by utility.

In the interest of your safety and to ensure the correct use, before installing and first using the appliance, read this user manual carefully, including its hints and warnings.

To avoid unnecessary mistakes and accidents, it is important to ensure that all people using the appliance are thoroughly familiar with its operation and safety features.

Save these instructions and make sure that they remain with the appliance if it is moved or sold, so that everyone using it through its life will be properly informed on appliance use and safety.

1.2 Child Safety

- This appliance is not intended for use by young children or infirm persons without supervision.
- Young children should be supervised to ensure that they do not play with the appliance.
- The packaging components (e.g. plastic film, polystyrene) can be dangerous to children - danger of suffocation! Keep them out of children's reach.
- Keep all detergents in a safe place out of children's reach.
- Make sure that children or pets do not climb into the drum.
- This machine is provided with child safety lock option () to prevent children playing with the control panel. (see page 14)

1.3 General Safety

- Any objects such as coins, safety pins, nails, screws, hairpin, toothpick, stones or any other hard, sharp material can cause extensive damage and must not be placed into the machine.
- Only use the advised quantities of fabric softener and detergent. Damage to the fabric can ensue if you overfill. Refer to the manufacturer's recommendations of quantities.
- This appliance is not intended for use by persons (including children) with reduced physical, sensory or mental capabilities, or lack of experience and knowledge, unless they have been given supervision or instruction concerning use of the appliance by a person responsible for their safety.
- Wash small items such as socks, laces, washable belts etc in a washing-bag or pillow case as it is possible for such items to slip down between the tub and the agitator.
- Always unplug the appliance and turn off the water supply after use, clean and maintenance.
- Under no circumstances should you attempt to repair the machine yourself. Repairs carried out by inexperienced persons may cause injury or serious malfunctioning. Contact your local Service Centre. Always insist on genuine spare parts.
- If the supply cord is damaged, should the appliance power supply cable need to be replaced, this shall be carried out by our Service Centre.

1.4 Installation

- When unpacking the appliance, check that it is not damaged. If in doubt, do not use it and contact the Service Centre.
- The appliance should not be installed in a humid place. The machine should be installed indoors without touch the rain.
- After having installed the appliance, check that it is not standing on the inlet and drain hose.
- If the machine is situated on a carpeted floor, please adjust the feet in order to allow air to circulate freely.
- Always be sure, that there is no water leakage from hoses and their connections after the installation.
- Any plumbing work required to install this appliance should be carried out by a qualified plumber.
- Any electrical work required to install this appliance should be carried out by a qualified electrician.
- Make sure that the drainage is working properly.

 May cause electric shock! if the machine is not connected to an earthed/ground system. **DO NOT** touch the wet clothes and metal parts.

 For safety reasons do not use double adaptors, extension cords and multi-plug adapters.



- Water pressures between minimum 50kPa and maximum 800kPa are acceptable.

1.5 Use

- This appliance is designed for domestic use. It must not be used for purposes other than those for which it was designed.
- Only wash fabrics which are designed to be machine washed. Follow the instructions on each garment label.
- Do not overload the appliance. See the relevant section in the user manual.
- Before washing, ensure that all pockets are empty and buttons and zips are fastened. Avoid washing frayed or torn articles and treat stains such as paint, ink, rust, and grass before washing.
- Garments which have been in contact with volatile petroleum products should not be machine washed. If volatile cleaning fluids are used, care should be taken to ensure that the fluid is removed from the garment before placing in the machine.
- Never pull the power supply cable to remove the plug from the socket, always take hold of the plug itself.
- Never use the Top-load Washing Machine if the power supply cable, the control panel, the working surface or the base are damaged so that the inside of the Top-load Washing Machine is accessible.



Do not touch the power plug while your hand still wet.



Do not put your hand, foot, or anything under the washing machine while the machine is operated.

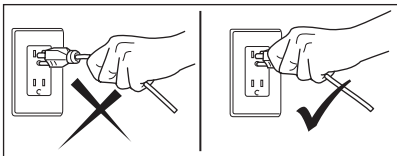

2.PRODUCT DESCRIPTION

2.1 Parts

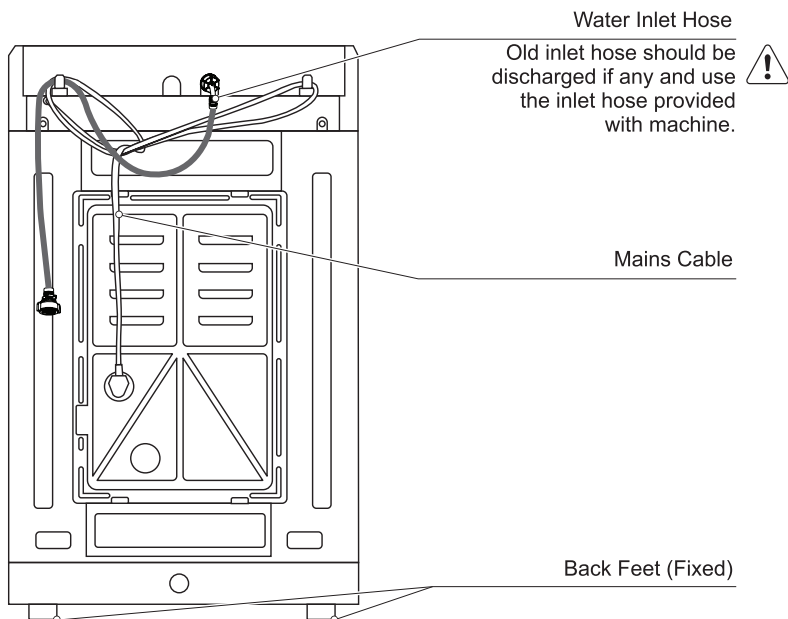
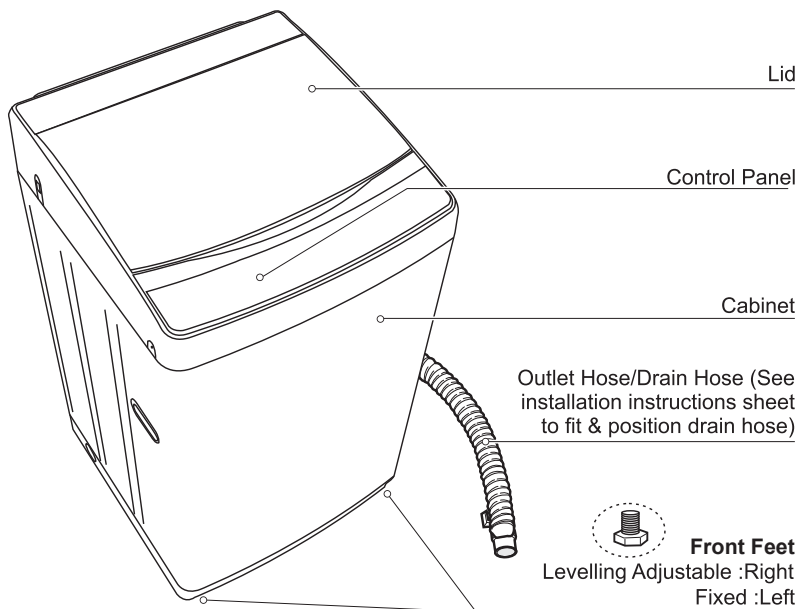

2.2 Product Features

Auto sensing water level

Auto sensing is a feature where the washer fills automatically with water to just the right level for your clothes load.

You do have the option to manually set the water level if you wish.

We recommend you use the auto sensing water level option to ensure there is just the right amount of water for the wash load in the machine. In other words, it will usually give you the best wash while also being the most efficient in terms of water usage.

At times during a wash it may appear your machine is either doing nothing or intermittently it is only gently vibrating/jiggling/agitating.

This is because your machine could be:

- In auto sensing test mode and the machine is determining the correct amount of water for your wash.
- At a drain stage of the wash program and the machine is allowing time for water to flow the washbowl to the out bowl.
- Engaging or disengaging the drive clutch mechanism. wait a short time, your washing machine will complete the above tasks and continue with the wash.

The amount of water for auto is factory set at an optimised level. You can adjust the Auto level up or down by a small amount.

Power Failure Recovery

When there is power failure while machine is washing or rinsing or spinning. The machine tries to save the settings at which stage the machine is doing and then when the power returns back the machine will starts washing from the stage where it is left off.

- When supply voltage is lower than 170V, PCB maybe can not start normally or machine will switch off power automatically if machine is working, power failure recovery function will be not working in this situation, you have to press “ Power” button to switch on the power and restart the program after voltage restored to 170V or above.
- When supply voltage is lower than 187V but above 170V, drainage maybe can not work normally and display shows error code “E1” due to drainage timeout, you have to press “Start/Pause” button to continue the unfinished work after voltage restored to 187V or above.

3.CONTROL PANEL

3.1 Control Panel Description

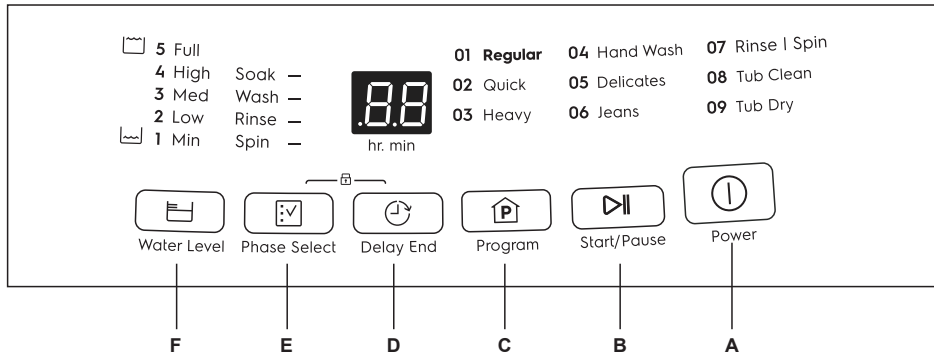

A Power	Push the “Power” button to switch on the power. Under power-on mode, push it to switch off the power. Push the “power” button to switch on the power. If the switch off the power automatically after 10 minutes.
B Start Pause	After the power is switched on, press it to start the machine. The washing machine running in accordance with the set operation procedures. After starting up, directly click this button, the machine will running according to commonly program. Press the pause button, we can reset the corresponding “Phase Select” and “water level”, press this button again, continue the former program or running according to the new set program. During working, push it to pause. During pause, push it to restart and go on working.
C Program	This model with 9 wash programs for optional. The default wash program is “Regular ”. Each time the button is pressed, the washing program changes; Regular/Quick/Heavy/ / Hand Wash/Delicates/Jeans / Rinse I Spin/Tub Clean/Tub Dry
D Delay End	When choose “Delay End” button to select suitable delay wash program. After switching on the power, the reserve time program is set to off mode automatically. If you need to set the washing procedure to be finished at delay timeplease push the “Delay End” button to set the reserve washing program. During operation, the digital tube will display the remained time (hours). Push down the delay button. The delay indicator light is on , the digital displays the delaytime of finishing washing (in hour). The point light flashes to indicate in the reverse mode. When the “Delay End” function is activated, the indicator light of the program you have set will be off. The “Delay Time” and “Remaining Time” indicator lights will be on. During Delay procedure, push the “Delay End” button to display the relay mode. To change the running program or cancel the delay setting, you need to switch off the powerand make new selection. When you choose “Delay End” button: 2 hours -3-4 -5-6 -- 23-24 - remaining time(No delay wash) circulation.
E Phase Select	Touch the “Phase Select” button could select single wash process or combine of wash Phase Select. When the machine running on which kind of the process, the digital will lightat the right position - flash during the Phase Select running, and light off after the Phase Select finished.
F Water Level	When choose “water level”, there are 5 water gears choose according to the quantity of clothes, the display screen shows the water level No.: 1 - 2 - 3 - 4 - 5.

3.2 Program Chart

Program;	Total program time (min)					Type of load and soil level
	 Water Level					
	5	4	3	2	1	
Regular	53	51	48	45	43	Daily washing, common wash program.
Quick	-	-	31	28	27	Speedy washing for light soil / new clothes / summer clothes.
Heavy	59	-	-	-	-	For heavily soiled clothes / bed sheets/blanket.
Hand Wash	76	74	61	58	56	Washing with hand wash & 3 times rinse - rinsing thoroughly.
Delicates	-	45	44	42	-	Daily silk, washing gently.
Jeans	59	57	-	-	-	High wash ability, suitable to wash jeans or serious stained clothes.
Rinse Spin	36	36	35	34	34	Rinse for two times and spin for one time.
Tub Clean	-	-	21	-	-	Used for cleaning the tub body regularly to prevent the growth of bacteria.
Tub Dry	-	-	-	-	-	Used for drying the tub body

Model : EWT7078K6WA 7 kg
 EWT8078K6WA 8 kg
 EWT9078K6WA 9 kg
 EWT0H78K6WA 10.5 kg

3.3 Program Options Compatibility





Program	Option				
	Soak	Wash	Rinse	Spin	Delay End
Regular	■	■	■	■	■
Quick	□	■	■	■	■
Heavy	■	■	■	■	■
Hand Wash	■	■	■	■	■
Delicates	■	■	■	■	■
Jeans	■	■	■	■	■
Rinse Spin	□	□	■	■	■
Tub Clean	□	■	□	■	□
Tub Dry	□	□	□	■	□

Remark

Unavailable select option

Available select option

Use of laundry detergent and softener

Max Clothes Quantity	Max kind of detergent Max Water level	Inspissation		Normal	
		 Powder	 Liquid	 Powder	 Liquid
10.5kg	High(L5)	About42g	About42ml	About74g	About74ml
3.0kg	Mid(L3)	About35g	About35ml	About60g	About60ml
1.5kg	Low(L1)	About29g	About29ml	About50g	About50ml

3.4 Options

Power Button



Push the "Power" button to switch on the power. Under power-on mode, push it to switch off the power. Push the "power" button to switch on the power. If the switch off the power automatically after 10 minutes.

Start/Pause Button



After the power is switched on, press it to start the machine. The washing machine running in accordance with the set operation procedures. After starting up, directly click this button, the machine will running according to commonly program. Press the pause key, we can reset the corresponding "Phase Select" and "water level", press this key again, continue the former program or running according to the new set program. During working, push it to pause. During pause, push it to restart and go on working.

Program Button



This model with 9 wash programs for optional. The default wash program is "Regular".

Each time the button is pressed, the washing program changes: Regular/
Quick/Heavy/Hand Wash/
Delicates/Jeans/Rinse I Spin/
Tub Clean/Tub Dry

Delay End Button



When choose "Delay End" button to select suitable delay wash program. After switching on the power, the reserve time program is set to off mode automatically. If you need to set the washing procedure to be finished at delay time please push the "Delay End" button to set the reserve washing program. During operation, the digital tube will display the remained time (hours). Push down the delay button. The delay indicator light is on, the digital displays the delay time of finishing washing (in hour). The point light flashes to indicate in the reverse mode. When the "Delay End" function is activated, the indicator light of the program you have set will be off. The "Delay Time" and "Remaining Time" indicator lights will be on. During Delay procedure, push the "Delay End" button to display the relay mode. To change the running program or cancel the delay setting, you need to switch off the power and make new selection. When you choose "Delay End" button:
2 hours -3-4 -5-6 -- 23-24 -
remaining time (No delay wash)
circulation

Phase Select Button

Touch the “Phase Select” button could select single wash process or combine of wash Phase Select. When the machine running on which kind of the process, the digital will light at the right position - flash during the Phase Select running, and light off after the Phase Select finished.

Water Level Button

When choose “water level”, there are 5 water gears choose according to the quantity of clothes, the display screen shows the water level NO.: 1-2-3-4-5

3.5 Settings

Child Safety Lock () Option

This function is for protecting children, the elderly and the frail.

1. Press the Power button.
2. After select one program then press “Start/Pause ”button.
3. To activate the Child Lock function, touch and hold both the “Delay End” and “Phase Select” button down simultaneously for 3 seconds. (If the Child Lock function is activated, the Digital tube will display “CL”.)

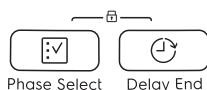

4. Operations after activating the Child Lock function. Even if the Child Lock function is activated, every button works until the door opens. When you open the door during the Child Lock is being activated. The alarm sounds and an error message appears in 5 seconds, draining begins automatically. However, if you close the door within 5 seconds, water will not be drained. (Displayed error message “E5”). To add laundry after activating the Child Lock function, you must deactivate the Child Lock function. The Power button is disabled while the washing machine drains water in Child Lock mode.

5. To deactivate the Child Lock function, press and hold both the “Delay End” and “Phase Select” buttons simultaneously for 3 seconds again. (If the Child Lock function is deactivated, the Child Lock display is turned off.)

4. DAILY USE

4.1 Starting Your Washing Machine

1. Connect the mains plug to the mains socket.
2. Turn the water tap on.

4.2 Load The Washing Machine

When loading the clothes into your washing machine, there are four things to remember:

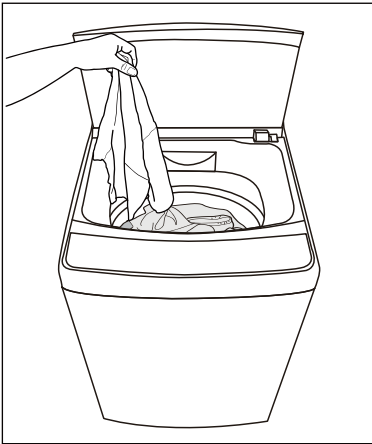

1. Clothes must be loaded evenly around the agitator. For best results load small items first, followed by large items.
2. Clothes must not be wrapped in the tub.
3. The washing machine must not be overloaded. Clothes must be able to move during wash.
4. The load should contain only three or four large items, for example sheets. The rest of the load should be small items. A mixed load of large and small items will wash cleaner than a load of all large items.

Liquid Detergent

Pouring onto the clothes.



Washing Powder

Pouring onto the drawer.

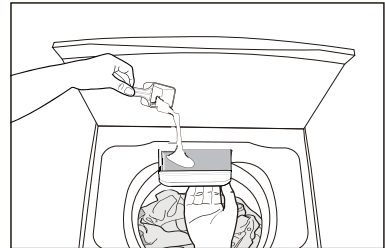

- Do not use gelatinous or thick liquid detergents.

4.3 Add Fabric Softener

1. EWT7078K6WA/EWT8078K6WA
EWT9078K6WA Model
- 1.1 Measure the correct amount of fabric softener by following the recommendations on the package.
- 1.2 Mix softener with an equal amount of warm water but only mix enough to fill to the line marked inside the cup. The softener cup holds 75ml.
- 1.3 Pour the fabric softener down the hole in the top of washing tub during fill when there is some water in the washbowl by tilted the washing tub as picture below.



Do not spill fabric softener on the clothes as it may stain them

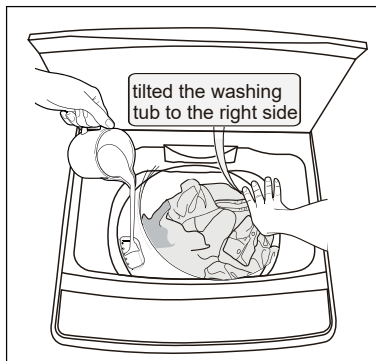

1.4 Turn Program selector to Rinse & Spin

2. EWT0H78K6WA Model

2.1 Pour softener into right compartment of detergent box as below picture.

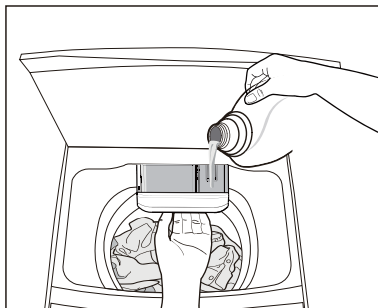

2.2. After adding softener, select any main washing program and start washing.

i NOTE

- The softener amount used must not exceed the "MAX" mark in the cup.
- If you use thick softeners it is recommended to dilute with water.

i NOTE

Residues of softener and water may remain in the cup. It is recommended to clean the cup regularly to remove any residue.

4.4 Setting a Program

1. Press Power (ⓘ) button, turn the program selector to the required program.
 - Your washing machine is now in STAND-BY-MODE and ready to wash your clothes.
 - The relevant light will light up.
 - The buzzer will sound.
 - The selector dial can be turned either clockwise or anticlockwise.
 - Once you selected a program, the program selected will stay at that position for the whole of the cycle.
 - The display shows the program duration.

If the settings shown on the control panel are what you want to use, press the Start/Pause button to start your wash.

2. If you want your laundry to be washed with functions different from the one proposed by the machine, press Water Level, Soak, Rinse and Spin option button.

i NOTE:

Different functions can be combined which is dependent on the program selected. When these button are pressed, the corresponding pilot lights come on.

3. If you want to define the end of the washing program, press the "Delay End" button repeatedly to choose your machine end time.

4.5 Starting a Program

To start a program, press the Start/Pause (▶||) button a default program duration will be displayed on the screen.

NOTE

When you select the Rinse +Spin program, there will be a delay of at least 2 minutes before the washing machine starts to spin.

This delay is a drain out period to ensure the bowl is empty of water, which is necessary before spin commences. Even though you may have only put wet clothes into an empty bowl, the delay before spin will still occur to be safe and to protect your washing machine.

4.6 Interruption Of A Program

If you have started your wash and you wish to stop it for some reason, press the Start/Pause button to enter PAUSE mode.

The time remaining is blink and the Start/Pause LED will start flashing. Press the Start/Pause again. The program will continue.

4.7 Changing A Program

Changing a running program is possible only by switching off the appliance.

- Press the "Power" button to cancel the program and to turn off the appliance.
- Press the "Power" button again to start the appliance.

Now you can set a new wash program and change any available options. Press Start/Pause to start the new program.

4.8 Changing The Options

It is possible to change only some option after the program has started.

1. Press the Start/Pause button to enter PAUSE mode.
2. Change the options.
3. Press Start/Pause button again. The program will continue.

4.9 At The End Of The Program

- The appliance stops automatically.
- Flashing with 3 consecutive long beeps.
- Remove the laundry from the appliance. Make sure that the washing tub is empty.
- Keep the lid ajar, to prevent the mildew and odours.
- Turn off the water tap.

5. WASHING HINTS

These Washing Instructions are of a general nature and you should get good wash results by following them.

However, due to the variables of fabric types, soil levels, detergent types and available program settings you may find some combinations of these which do not always result in the perfect wash.

If for example you see residuals of detergent or soils on some items, please read the section Residues on washed items paragraph.

Over time you will learn what is the best set-up of programs, detergent and load sorting for different load types and soils.

5.1 Sort Your Washing Into Separate Wash Loads



- Each load of washing should contain clothing which needs the same washing conditions. For example, you should not wash delicate clothes with very dirty work clothes.
- Colour fast and non-colourfast fabrics should be separated. Knowing the type of fabrics you have and how dirty they are will help when you make selections from the wash program options.
- Some fabrics are lint collectors and can pick up lint, dirt and colour from other fabrics which are lint producers. Some examples are listed below:

Lint collectors	Lint producers
<ul style="list-style-type: none"> - Corduroy - Synthetics - Permanent press fabrics 	<ul style="list-style-type: none"> - Towels - Nappies - Chenille/Candlewick

i NOTE:

Make sure that you wash lint collectors separately from lint producers.

- Never wash whites and coloured together. Whites may lose their "whiteness" in the wash.
- New coloured items may run in the first wash; they should therefore be washed separately the first time.

! IMPORTANT!

Make sure that no metal objects are left in the laundry (e.g. hair clips, safety pins, pins).

- Button up pillowcases, close zip fasteners, hooks and poppers.

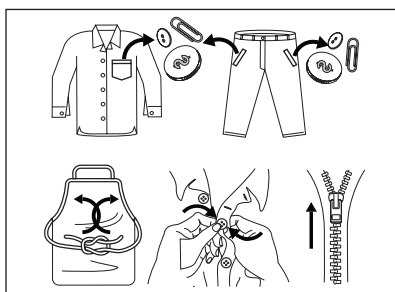

- Tie any belts or long tapes.
- Remove persistent stains before washing.
- Rub particularly soiled areas with a special detergent or detergent paste.
- Treat curtains with special care.
- Wash bras, pantyhose and other delicates in a mesh laundry bag, which you can purchase from your supermarket.

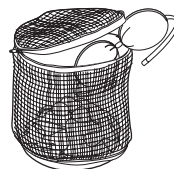

- Remove hooks or tie them up in a bag or net.

5.2 Detergent

Good washing results also depend on the choice of detergent and use of the correct quantities to avoid waste and protect the environment.

Although biodegradable, detergents contain substances which, in large quantities, can upset the delicate balance of nature.

The choice of detergent will depend on the type of fabric (delicates, woollens, cottons, etc.), the colour, washing temperature and degree of soiling.

- Don't use the wrong type of detergent. You must use a designed for Top load washing machines or high efficiency top loaders, such as Cold Power for Top Loaders and High Efficiency Top Loaders or detergents labelled "Matic".
- Don't use soap-based products in your washing machine.
- Don't use too much detergent. This can result in excessive suds that can cause low spin speeds, poor rinsing and overloading the motor during spin stages of the wash program.
- Don't use too little detergent because you will get a poor wash. If you think you need more, increase dosages by only small amounts to avoid excessive suds.

Quantity of detergent to be used

The type and quantity of detergent will depend on the type of fabric, load size, degree of soiling and hardness of the water used.

Water hardness is classified in so-called "degrees" of hardness.

Information on hardness of the water in your area can be obtained from the relevant water supply company, or from your local authority.

Follow the product manufacturer's instructions on quantities to use.

- Not enough washing powder causes: the washload to turn grey, greasy clothes.
- Too much washing powder causes: sudsing, reduced washing effect, inadequate rinsing.
- Use less detergent if: you are washing a small load, the laundry is lightly soiled, large amounts of foam form during washing.

5.3 A Guide To Stain Removal

Stubborn stains may not be removed by just water and detergent. It is therefore advisable to treat them prior to washing.

Blood: treat fresh stains with cold water.

For dried stains, soak overnight in water with a special detergent then rub in the soap and water.

Oil based paint: moisten with benzine

stain remover, lay the garment on a soft cloth and dab the stain; treat several times.

Dried grease stains: moisten with

turpentine, lay the garment on a soft surface and dab the stain with the fingertips and a cotton cloth.

Rust: A rust removing product used in cold water. Be careful with rust stains which are not recent since the cellulose structure will already have been damaged and the fabric tends to hole.

Mould stains: treat with bleach, rinse

well (whites and fast coloureds only).

Grass: soap lightly and treat with bleach

(whites and fast coloureds only).

Ball point pen and glue: moisten with acetone (*), lay the garment on a soft cloth and dab the stain.

Lipstick: moisten with acetone (*) as above, then treat stains with methylated spirits. Remove any residual marks from white fabrics with bleach.

Red wine: soak in water and detergent,

rinse and treat with acetic or citric acid, then rinse. Treat any residual marks with bleach.

Ink: depending on the type of ink,

moisten the fabric first with acetone (*), then with acetic acid; treat any residual marks on white fabrics with bleach and then rinse thoroughly.

Tar stains: first treat with stain remover,

methylated spirits or benzine, then rub with detergent paste.

(*) do not use acetone on artificial silk.

6. CARE AND CLEANING

6.1 Cleaning The Dispenser

The dispenser needs to be cleaned regularly, preferably after each wash. Inspect the dispenser after each wash to see if there is any residue of detergent.

To do this proceed as follows :

1. Remove dispenser drawer from its places.

Pull out the dispenser drawer until it stops then lift up and pull out from the recess.

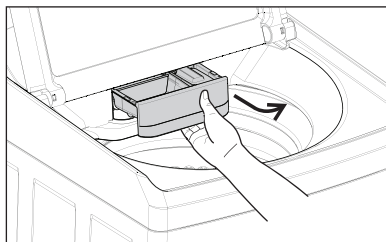

2. Clean the dispenser drawer with water and a brush, eg. an old toothbrush.

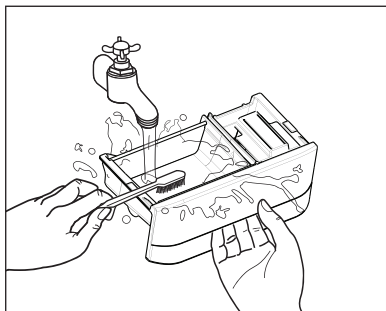

6.2 Cleaning The Drawer Recess

Having removed the drawer, use a small brush to clean the recess, ensuring that all washing powder residue is removed from the upper and lower part of the recess. Replace the drawer and run the rinse program without any clothes in the drum.

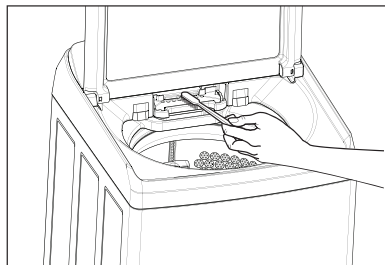

6.3 Clean The Inner Tub Filter

1. Push out the filter from the inner tub
2. Over turn the filter clean it in water get rid of the thread
3. Reinstall the filter

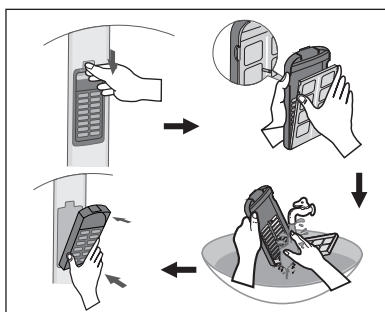

6.4 Cleaning The Water Inlet Filter

If your water is very hard or contains traces of lime deposit, the water inlet filter may become clogged. It is therefore a good idea to clean it from time to time.

To clean the water inlet filters:

1. Close the water tap.
2. Remove the water inlet hose from the water tap.
3. Clean the filter in the inlet hose with a stiff brush.

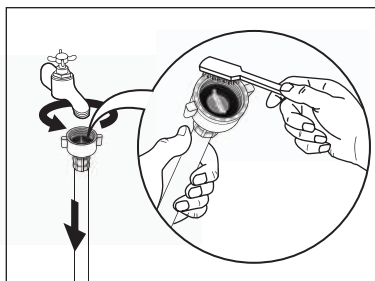

- Remove the inlet hose behind the appliance.

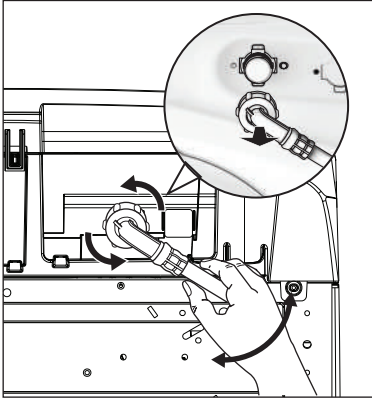

- Clean the filter in the valve with a stiff brush or a towel.

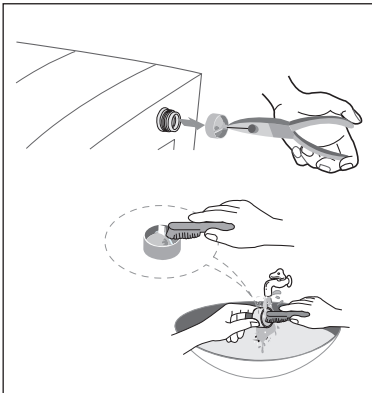

- Install the inlet hose again. Make sure that the couplings are tight to prevent leakages.
- Open the water tap.

6.5 Cleaning Your Washing Machine

To clean the inside and outside of your washing machine you should:

- Wipe the surface with warm water.
- Wipe dry with a soft cloth.

i Important:

Never use solvents, alcohol, aerosol cleaners, spray pack cleaners, glass cleaners, metal polishes, caustic materials, scourers or general household cleaners on or near the top panel and lid, control panel or other parts of your washing machine.

6.6 Cleaning Stains In The Washbowl

Stains in the wash bowl can be caused by:

- metal objects such as bobby pins, dressmaking pins and nails;
- salt;
- body oils and grease from very dirty or sweaty clothes being deposited around the top of the washbowl;
- excessive foam during wash if incorrect or too much detergent is used.

i Important:

Check all pockets before loading clothes into your washing machine.

Don't leave wet clothing (especially swimwear) in the bowl for too long before you wash it.

How To Clean the Stainless Steel Wash Bowl :

- Wipe with a cleaning product which is marked suitable for stainless steel.
- Oily deposits can be removed by wiping surfaces with a mild dishwashing detergent and warm water.

i Important:

Never use bleach cleaners or steel wool to clean the stainless steel washbowl.

7.TROUBLESHOOTING

7.1 Possible Failures

DO NOT call for service until you have checked the points listed below. If you call for service and there is nothing wrong with your washing machine, you will have to pay for the service call.

You will have to pay even when your washing machine is under warranty. Before you call for service, check the points in the table below. If after all checks, the problem persists, contact your local Service Centre.

Description	Errorcode	Checking point	Solution plan
Water inlet timeout	E0	Check the user's water inlet system (such as whether tap is turned on)	Open the tap
		Check whether the filter in water inlet valve is blocked	Remove and clean the filter
		Check whether the water inlet valve is working (vibrating), if not,contact service team	contact service team
Drainage timeout	E1	Check if drain hose was placed on too high position	To put drain hose on level ground
		Contact service team in case no drainage action	contact service team
Top lid is not closed during "Delay start" or "Spin"	E2	Check top lid is closed or not	close top lid
Imbalance for three times during spinning	E3	Check whether the machine is placed on the level ground	Adjust the foot to make the washing machine level
		Clothes placement is uneven	Manual adjustment of clothes to put it even
Water level higher than highest water level	E4	Check if any excessive water added by human	Machine will drain out the extra water till proper water level
Water level lower than lowest water level		Check if any leakage	Contact service team
Water level sensor failure		/	Contact service team
Top lid is opened during "Child lock"	E5	Check if top lid was opened during "child lock"	Close the top lid in five seconds; Five seconds later, press"Program" and "Delay start"button at the same time for more than 2 seconds, "child lock" function is cancelled.
The fuzzy judgment value is not in the valid range	E8	Check if motor belt was loose or motor was stuck	contact service team

7.2 Yellowing Or Greying Clothes

Problem	Possible causes	What to do
Greyness	<ul style="list-style-type: none"> • Incorrect wash times and using insufficient detergent which can cause redepositing of detergent on clothes. • Using incorrect type or too much detergent can cause poor rinsing and poor spin performance. • Mixing whites with very dirty clothes, eg work clothes. • Using soap flakes instead of laundry detergent. 	<ol style="list-style-type: none"> 1. ONLY use top load washer detergent in this machine, such as Cold Power for Top Loaders and High Efficiency Top Loaders or detergent labelled "Matic". 2. Re-sort load, then re-wash using program selections suitable for the fabric. 3. If the water is very dirty or very sudsy, repeat 2 above reducing the amount of detergent you use.
Yellowing	<ul style="list-style-type: none"> • A build-up of oils in clothes that come into close contact with the skin, eg underwear, T-shirts. • Ageing of clothes. Iron deposits in the wash water. • Use of chlorine bleaches on fabrics with resin finishes. • Incorrect drying. 	<ol style="list-style-type: none"> 1. Re-sort load, then re-wash using wash program selections suitable for the fabric. 2. If the water is very dirty or very sudsy, repeat 1 above reducing the amount of detergent you use.

8. TECHNICAL DATA

Model no:	EWT7078K6WA	EWT8078K6WA
Rated voltage:	220V~	220V~
Rated frequency:	50Hz	50Hz
Washing capacity:	7.0kg	8.0kg
Spinning capacity:	7.0kg	8.0kg
Water resistant degree:	IPX4	IPX4
Rated input power for washing:	400W	400W
Rated input power for spinning:	300W	300W
Net dimensions:	525×560×950mm	550×592×965mm
Packaged dimensions:	575×610×1005mm	630×640×1015mm
Net/Gross weight:	31kg/35kg	32kg/37kg

Model no:	EWT9078K6WA	EWT0H78K6WA
Rated voltage:	220V~	220V~
Rated frequency:	50Hz	50Hz
Washing capacity:	9.0kg	10.5kg
Spinning capacity:	9.0kg	10.5kg
Water resistant degree:	IPX4	IPX4
Rated input power for washing:	400W	500W
Rated input power for spinning:	300W	350W
Net dimensions:	550×592×965mm	580×620×980mm
Packaged dimensions:	630×640×1015mm	685×685×1040mm
Net/Gross weight:	34kg/39kg	39kg/44kg

1) Maximum capacity depended on the model of the Washing Machine.

EWT7078K6WA	7 kg
EWT8078K6WA	8 kg
EWT9078K6WA	9 kg
EWT0H78K6WA	10.5 kg

9. INSTALLATION

9.1 Unpacking

1. Remove the cardboard box and styrofoam packing..

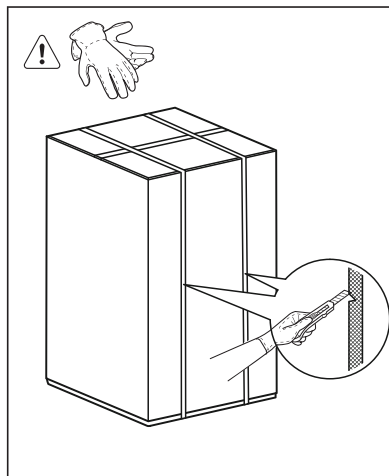

2. Remove the plastic bag which cover the machine. Remove the polystyrene piece.

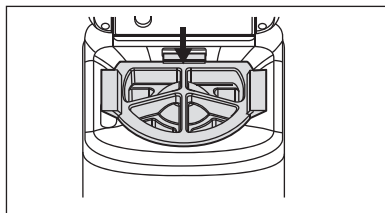
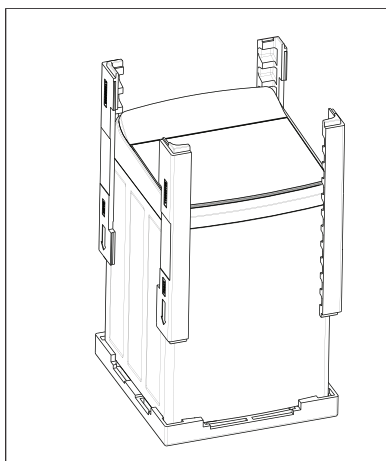

! **Important:** The top polystyrene must be removed **LAST**, for protecting the washing tub from hitting the cabinet when the machine is tilted.

3. Put one of the polystyrene packaging elements on the floor behind the appliance. Carefully put down the appliance with the rear side on it. Make sure not to damage the hoses.

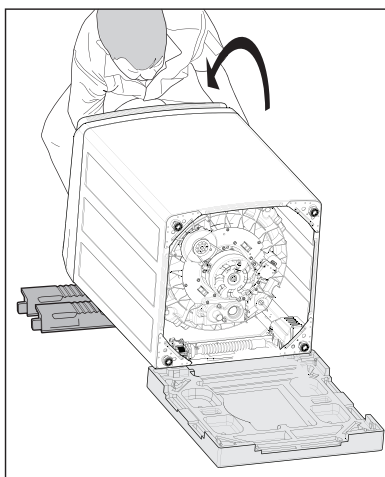

! **Caution:** Pay attention to the machine lid, may hit your body.

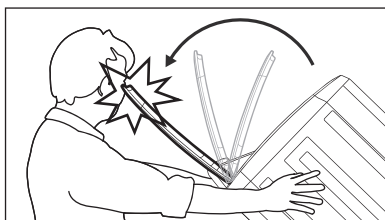

4. Remove the polystyrene base.

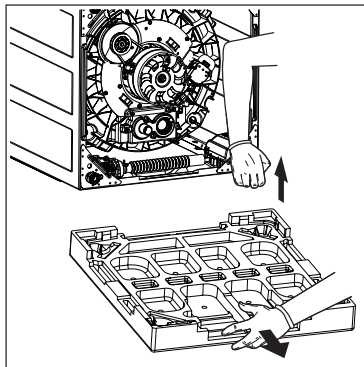

5. Insert the Bottom Cover into slot at the bottom of the machine (as shown on picture).

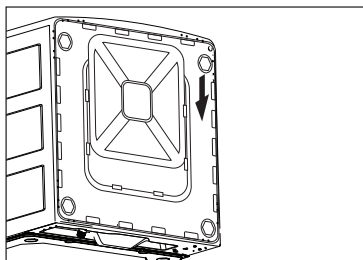

6. Use the Metal screws Lock provided in the user manual bag to secure the Bottom Cover to the bottom of the cabinet.

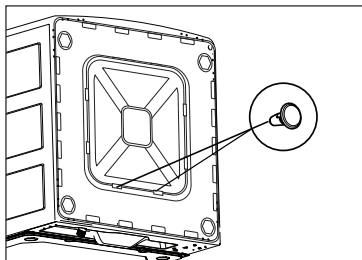

7. Pull up the appliance in vertical position.
8. Open the lid. Remove the polystyrene piece from top panel and all the items from the washing tub.

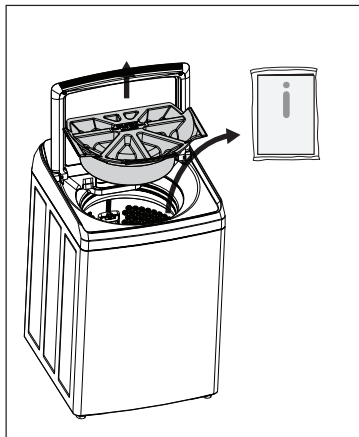

9.2 Positioning

It is important that your washing machine stands firm and level on the floor to ensure correct operation.

Use a spirit level on the front and side panels of the washing machine to check the levels. The spirit level should be used close to the corners of the washing machine for accuracy. By hand, or using a spanner if necessary, the left front leg is adjustable and the other legs are factory fitted in a fixed position (Unadjustable legs have a round base).

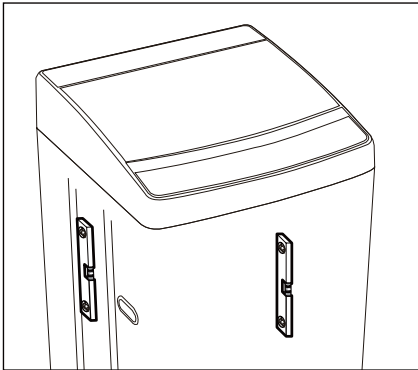

Tilt the washer a little to adjust the left front leg.

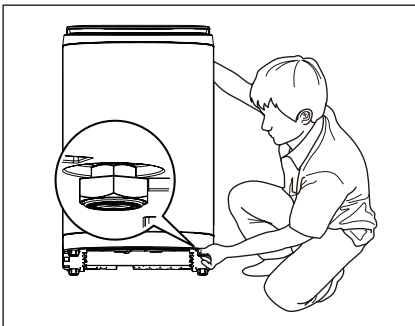

Never place cardboard, wood or similar materials under the machine to compensate for any unevenness in the floor.

Install the machine on a flat hard floor. Make sure that air circulation around the machine is not impeded by carpets, rugs etc. Check that the machine does not touch the wall or cupboard units.

When the washing machine is levelled, try to rock it from corner to corner. If it does rock, adjust the legs again until it is levelled and does not rock.

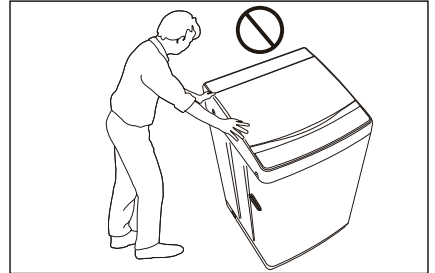

9.3 Water Inlet

Connect the water inlet hose to a tap with 3/4" BSP thread.

When installing this washing machine, use the hoses supplied. **DO NOT USE OLD HOSES.** The inlet hoses have the sealing washer fitted.

Connect the inlet hose to water tap. Make sure the connections are tight.

Turn the taps on and check that there are no leaks from the connections.

Turn off the water taps and move the washing machine into its final position. Make sure that the inlet and drain hoses do not kink.

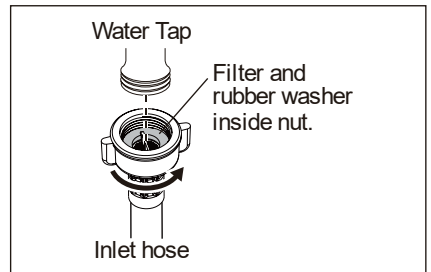

9.4 Installation of drain hose

1. Please use the drain hose from the accessory for installation, don't use any old drain hose.

2. You could find a clip from the bag along with drain hose to fasten the connection between drain hose and machine

3. Install drain hose with machine

3.1 if the sewage outlet is in opposite direction with drainage exit on side of machine, firstly connect the drain hose with drain exit, hold the clip of drain hose by left hand, push the drain hose into the machine in place by right hand, then loosen the clip to fasten the drain hose with machine, secondly put the drain hose from back side of machine to turn it in same same direction with sewage outlet and then insert it into sewage outlet as below image

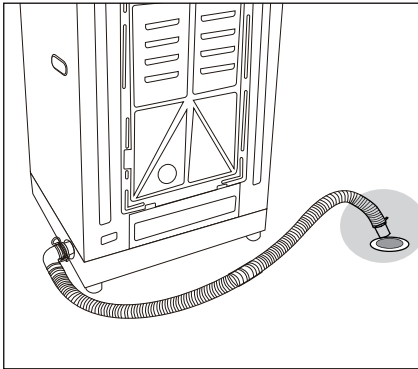

3.2 if the sewage outlet is in same direction with drainage exit on the side of the machine, firstly you should cut off the drain hose as below image, secondly connect the rear half part of drain hose with drain exit on side of machine properly and then insert it into sewage outlet.

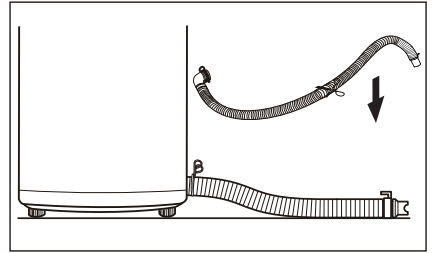

10. ENVIRONMENT CONCERNS

10.1 Packaging Materials



The materials marked with the symbol  are recyclable.

>PE<=polyethylene

>PS<=polystyrene

>PP<=polypropylene

This means that they can be recycled by disposing them properly in appropriate collection containers.

10.2 Old Machine

Use authorized disposal sites for your old appliance. Help to keep your country tidy!

The symbol  on the product or on its packaging indicates that this product may not be treated as household waste.

Instead it shall be handed over to the applicable collection point for the recycling of electrical and electronic equipment. By ensuring this product is disposed of correctly, you will help prevent potential negative consequences for the environment and human health, which could otherwise be caused by inappropriate waste handling of this product.

For more detailed information about recycling of this product, please contact your local city office, your household waste disposal service or the shop where you purchased the product.

10.3 Ecological Hints

To save water, energy and to help protect the environment, we recommend that you follow these tips:

- Normally soiled laundry may be washed without prewashing in order to save detergent, water and time (the environment is protected too!).
 - The machine works more economically if it is fully loaded.
 - With adequate pre-treatment, stains and limited soiling can be removed; the laundry can then be washed at a lower temperature.
 - Measure out detergent according to the water hardness, the degree of soiling and the quantity of laundry being washed.
-

NOTE

NOTE

www.electrolux.com



INDONESIA

Jl. Abdul Muis No.34, Petojo Selatan,
Gambir, Jakarta Pusat 10160, Indonesia
Hotline Service : 0804 111 9999
SMS : 0812 8088 8863
WA : 0811 8339 777
Email : customercareID@electrolux.com
Website : www.electrolux.co.id
Diimpor oleh PT Electrolux Indonesia

G0032xxx-001-A2069xxxx

